

# **SMART TWEEZERS**

## **R-C-L METER**



---

User's Manual  
Version 1.02

## TABLE OF CONTENTS

NOTICE .....	4
WARRANTY .....	4
SAFETY PRECAUTIONS .....	5
GETTING STARTED .....	6
Overview .....	6
Controls .....	7
Power On .....	7
Menu Structures And Functions .....	9
MEASUREMENT FEATURES .....	14
Measuring Resistance .....	15
Measuring Capacitance .....	15
Measuring Inductance .....	16
Measuring Voltage .....	16
MAINTENANCE .....	17
LABELLING & VERIFICATION REQUIREMENTS .....	17
APPENDIX A. SPECIFICATIONS .....	18
APPENDIX B. DEFAULT SETTINGS .....	19
APPENDIX C. SERVICE REQUEST FORM .....	20
APPENDIX D. ACCURACY SPECIFICATION .....	22

## NOTICE

To the best of our knowledge this document is believed to be accurate. The manufacturer reserves the right to change the information and does not assume any responsibility for omissions and / or errors found in this document.

## WARRANTY

Manufacturer warrants this product to be free from defects in materials and workmanship for a period of one (1) year from the shipment date. Manufacturer warrants the following items for ninety (90) days from the date of shipment: rechargeable batteries, disks and documentation. During the warranty period, the manufacturer will, at its discretion, either repair or replace any product that proves to be defective. To exercise this warranty, write or call your local distributor. You will be given prompt assistance and return instructions. Please send the product with shipping prepaid to the indicated service facility. Repairs will be made and the product will be returned to you. Repaired or replaced products are warranted for the balance of the original warranty period, or ninety (90) days from the date of the repair.

This warranty does not cover the repair of any product whose serial number has been altered, defaced or removed. This warranty does not cover finishes (scratches on surface or screen), normal wear and tear, nor does it cover damage resulting from misuse, dirt, liquids, proximity or exposure of heat, accident, abuse, neglect, misapplication, operation outside of the environmental specifications, tampering, unreasonable use, service performed or attempted by unauthorized service centers, failure to provide reasonable and necessary maintenance.

This warranty does not apply to defects resulting from product modification without manufacturer's express written consent, or misuse of any product or part. This warranty also does not apply to software, non-rechargeable batteries, damage from battery leakage, and improper polarity of the batteries or problems arising from normal wear or failure to follow instructions. This warranty does not cover LCD damage, physical damage to the Jog Dial button, slide switch and reset switch; electrical damage of the product due to high voltage or improper battery type.

The design and implementation of any circuit based on this product is the sole responsibility of the customer. Manufacturer does not warrant any damage that occurs as a result of the user's circuit or any defects that result from user-supplied products. This warranty does not apply to repairs or replacements necessitated by any cause beyond the control of factory including, but not limited to, operation contrary to furnished instructions, shipping accidents, modification or repair by the user, neglect, accidents or other Acts of God.

The foregoing is in lieu of all other expressed warranties and the manufacturer does not assume or authorize any party to assume for it any obligation or liability. The duration of any warranties that may be implied by law (including the warranties of merchantability and fitness) is limited to the term of this warranty. In no event shall the manufacturer be liable for special, incidental or consequential damages arising from ownership or use of this product, or for any delay in the performance of its obligations under this Warranty due to causes beyond its control. This Warranty is limited in duration to one (1) year from the date of original purchase.

**THIS WARRANTY IS IN LIEU OF ALL OTHER WARRANTIES, EXPRESSED OR IMPLIED, INCLUDING ANY IMPLIED WARRANTY OF MERCHANTABILITY OR FITNESS FOR A PARTICULAR USE. THE REMEDIES PROVIDED HEREIN ARE BUYER'S SOLE AND EXCLUSIVE REMEDIES. NEITHER MANUFACTURER, NOR ANY OF ITS EMPLOYEES SHALL BE LIABLE FOR ANY DIRECT, INDIRECT, SPECIAL, INCIDENTAL OR CONSEQUENTIAL DAMAGES ARISING OUT OF THE USE OF ITS DEVICES AND SOFTWARE EVEN IF MANUFACTURER HAS BEEN ADVISED IN ADVANCE OF THE POSSIBILITY OF SUCH DAMAGES. SUCH EXCLUDED DAMAGES SHALL INCLUDE, BUT ARE NOT LIMITED TO: COSTS OF REMOVAL AND INSTALLATION, LOSSES SUSTAINED AS THE RESULT OF INJURY TO ANY PERSON, OR DAMAGE TO PROPERTY.**

## SAFETY PRECAUTIONS

The following safety precautions should be observed prior to using this product and any associated accessories. Although devices and accessories would normally be used with non-hazardous voltages, there are situations where hazardous conditions may be present.

This product is intended for use by qualified personnel who recognize shock hazards and are familiar with the safety precautions required to avoid possible injury. Read and follow all installation, operation, and maintenance instructions carefully before using the product. Refer to the manual for complete product specifications.

If the product is used in a manner not specified, the protection provided by the product may be impaired.

- Inspect the Smart Tweezers case before using. Do not use the device if it appears to be damaged.
- Do not use the device if it operates abnormally.
- Do not attempt to measure any components in-circuit when your circuit is alive or active.

To avoid possible damage to Smart Tweezers or to the equipment under test, follow these guidelines:

- Disconnect circuit power supply and discharge all high-voltage capacitors before testing resistance, inductance, or capacitance.
- Do not apply external voltages of more than 1.6 V in the automatic mode.
- Do not apply more than 8V in the voltage measurement mode.
- Use proper terminals and functions for your measurements.
- Use proper batteries to power Smart Tweezers.

### ■ Safety symbols and terms

The **WARNING** heading in this manual indicates dangers that might result in personal injury or death. Always read the associated information very carefully before performing the indicated procedure.

The **CAUTION** heading in the manual indicates hazards that could damage the device. Such damage may invalidate the warranty.

## GETTING STARTED

This section summarizes basic operation of Smart Tweezers. In the section:

- **Overview** – Overview of the device
- **Controls** – Describes buttons and switches
- **Power-on** – Describes the power-on and power-off sequence, the warm-up time, and default conditions.
- **Display** – Discusses the display format and messages that may appear while using the device.
- **Menu structure** – Covers menu structure, system settings and features

### ■ Overview

Smart Tweezers (ST) is a portable impedance measuring device. ST is capable of measuring resistance, capacitance or inductance over a range of more than 8 orders of magnitude. The device has a basic accuracy better than 1% (resistance) and operates at four (4) test frequencies.

Smart Tweezers is controlled by a microcontroller that sets measurement conditions, processes data, operates the display and user interface. The device has a unique mechanical design that allows manipulation SMT components with size down to 0201.

ST evaluates impedance of a component by measuring the voltage across the component and current through it. The complex ratio of voltage to current is equal to the complex impedance. The processor calculates various parameters that are displayed i.e. R, C or L.

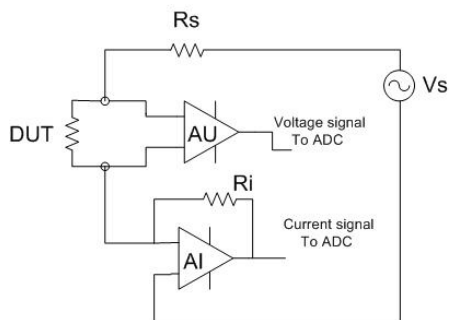

Voltage across the component is generated by the test signal source  $V_s$ . Both the amplitude and frequency of  $V_s$  can be set. The voltage is applied to the device under test (DUT) through the source resistance  $R_s$ . Current flows to the virtual ground of the current amplifier AI, and through the current conversion resistor  $R_i$ . The output of AI provides a signal proportional to the current,  $I \cdot R_i$ .

Voltage across the DUT is measured by a separate signal path (amplifier AU), thus providing a pseudo 4-wire Kelvin connection.

Voltage and current signals are processed by the A/D converter. Obtained values are then corrected using calibration factors, converted to impedance and sent to the display.

### ■ Controls

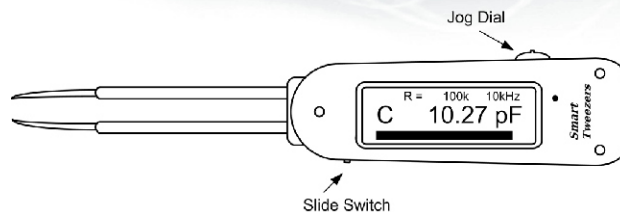

#### The Jog Dial Button

The Jog Dial button is used to select a function or to change a setting.

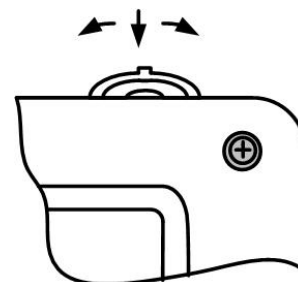

#### Slide Switch

The slide switch enables input voltage divider for DC VOLTAGE and TRACE mode measurements.

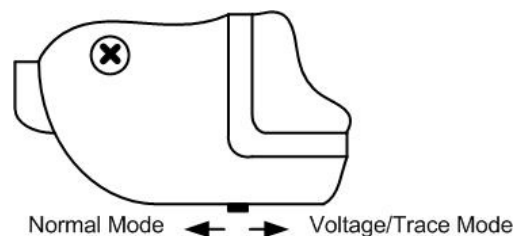

**CAUTION:** Do not apply more than 1.6 V to ST if the slide switch is in the Normal Mode position

### ■ Power On

#### Power-on

To turn the Smart Tweezers ON, press the Jog Dial button. The symbol at the bottom left corner of the display indicates that the device is ON and ready to perform measurements.

**Note:** Once powered on, the device will perform the last selected function.

## Power-off

ST powers off automatically, the display goes blank and the device goes into a “sleep” mode if no component has been measured nor the Jog Dial pressed for approximately 30 seconds. The power off timeout value can be set by changing the TIMEOUT setting in the DISPLAY menu.

**Note:** Automatic **power-off does not occur** if the unit is in the VOLTAGE or TRACE mode as well as at 10kHz test frequency.

## Default power-off settings

By default power-off timeout is 30 seconds in a measurement mode and 30 seconds in the MENU mode.

## Display

ST screen is divided into the Primary Display, Secondary Display, Bar Graph and Test Frequency Indicator areas.

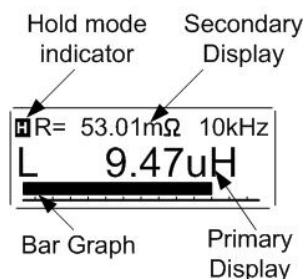

The sign at the bottom left corner of the display indicates that device is on and ready to measure. A, R, L, C, ▲ indicate Auto, Resistance, Inductance, Capacitance and Diode measurement mode respectively.

## Primary Display

The Primary Display takes the middle of the screen and is the larger one of the two. It shows the dominant parameter reading. For most functions the display shows 5 digits.

## Secondary Display

The Secondary Display is at the top of the screen and is the smaller of the two. It shows the minor parameter reading.

## Bar Graph

The Bar Graph provides an analog representation of the measured major parameter value and is located at the bottom of the screen.

## Displayed Parameters

The measurement mode setting (R, L+R, C+R, C+D, L+Q and AUTO) determines the measurement type and the displayed parameters. The selected parameters are indicated on the two displays.

## R Mode

Resistance is shown on the Primary Display and the quality factor, Q, on the Secondary Display. The resistance is either the equivalent series or parallel resistance of the DUT. Resistance units are mΩ, Ω, kΩ, or MΩ.

## L+R Mode

Inductance is shown on the Primary Display and the series resistance on the Secondary Display. The units of inductance are μH, mH or H. Resistance is the real part of the impedance. Resistance units are mΩ or Ω.

## L+Q Mode

Inductance is shown on the Primary Display and the quality factor Q on the Secondary Display. Inductance units are μH, mH or H. Q is the ratio of the imaginary part of the impedance to the real part of the impedance. Q is dimensionless and the same for both series and parallel representations. A good inductance has a large L and a small R and thus a high Q.

## C+R Mode

Capacitance is shown on the Primary Display and the parallel resistance R, is shown on the Secondary Display. The units of capacitance are pF, nF, or μF. Resistance units are Ω or kΩ.

## C+D

Capacitance is shown on the Primary Display and dissipation factor D on the Secondary Display. The capacitance is either the equivalent series or parallel capacitance of the DUT. The units of capacitance are pF, nF, Ω F or mF. D is the ratio of the real part of the impedance to the imaginary part of the impedance, or 1/Q. D is dimensionless and the same for series and parallel representations.

A good capacitor has a large C (imaginary) and a small R (real) and thus a low D.

## AUTO Mode

ST determines which component model is the most accurate representation of the DUT and selects the appropriate parameter pair. The determination is made as follows:

for  $|Q| < 0.15$  the R mode is selected.

for  $Q > +0.15$  the L+R or L+Q mode is selected (depends on user settings).

for  $Q < -0.15$  the C+R or C+D mode is selected.

## Menu Structures And Functions

This section describes menu structure and parameters setting.

- Main menu – main menu items
- System menu – system menu items
  - ▶ Sound menu – sound settings
  - ▶ Display menu – display settings
  - ▶ Service menu – service functions
- Measurement menu – measurement functions and settings
  - ▶ Mode menu – measurement modes
  - ▶ Setting menu – measurement parameters settings

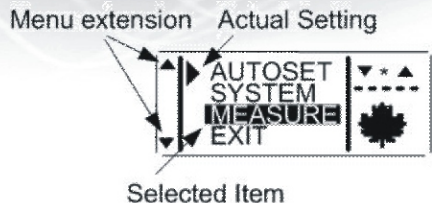

### **Navigating menus**

Turn Jog Dial to move the Selected Item cursor to the desired menu item and push Jog Dial to select the item. The Actual Setting cursor indicates the current setting.

#### **Main menu**



Main menu is used to access System menu, Measurement menu or to return measurement parameters to the default state using AUTOSET.

Select AUTOSET to reset parameters to the default settings.

Select SYSTEM to change user interface parameters.

Select MEASURE to specify measurement settings.

#### **System menu**



System menu is used to access system settings and functions.

#### **Sound menu**



Sound menu is used to change sound setting for measurement confirmation.

Select OFF (default) to disable sound except for a Jog Dial operation.

Select ON to enable sound for measurement confirmation.

#### **Display menu**

Display menu is used to change the display settings



Select RIGHT to set the "Right Handed" display mode

Select LEFT to set the "Left Handed" display mode

Select CONTR to adjust display contrast. Turn Jog Dial left or right to change contrast. Press Jog Dial to exit menu



#### **Timeout**

Select TIMEOUT to adjust "sleep" mode timeout. Turn Jog Dial left or right to change timeout value (10sec – 200sec) Press Jog Dial to exit menu.

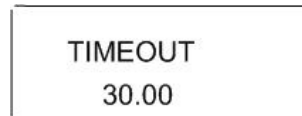

#### **Service Menu**

Service menu is used to perform a service function.



#### **OFFSET**

Select OFFSET function to perform calibration of the DC voltage offset. Perform this function before starting a Voltage measurement for better accuracy.

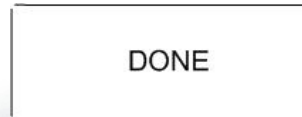
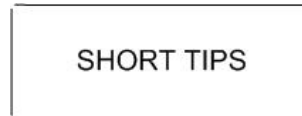

## BATTERY

Select BATTERY to measure the battery voltage. Press Jog Dial to exit

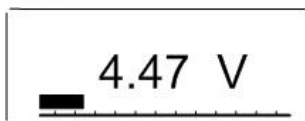

## SERIAL NUMBER

Select S/N to display device Serial Number.



## Measurement menu

### Measurement modes and settings



### Mode menu

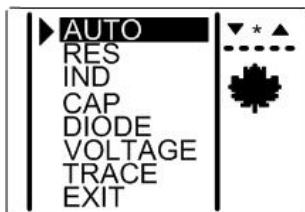

The Mode menu is used to set the measurement mode. For automatic measurement select **AUTO** (default). Select **RES**, **IND**, **CAP**, **DIODE**, **VOLTAGE** or **TRACE** menu items to measure desirable component or parameter accordingly.

### AUTO mode

Select **AUTO mode** for automatic measurement of inductance, capacitance or resistance.

**Note:** In the **AUTO** mode ST uses by default 1 kHz test frequency and has a limited sensitivity to small capacitance and inductance.

### RESistance mode

Enables Resistance measurement mode. See section MEASUREMENT FEATURES for more information.

### INDuctance mode

Enables Inductance measurement mode. See section MEASUREMENT FEATURES for more information.

## CAPacitance mode

Enables Capacitance measurement mode. See section MEASUREMENT FEATURES for more information.

### Diode mode

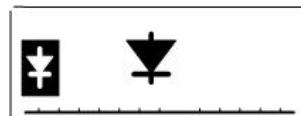

ST automatically shows polarity of the diode. If the diode is shorted the following message appears on the display:

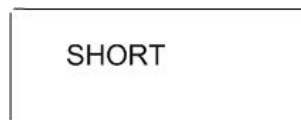

### Voltage mode

Enables the DC voltage measurement mode. Input voltage range is  $-/+8V$ .

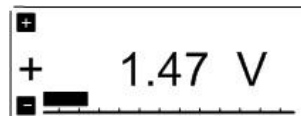

ST automatically shows polarity of the input voltage.

### Trace mode

Select the TRACE mode to display oscilloscope-like picture of the dynamic input signal in real time. To change sampling rate turn Jog Dial button LEFT or RIGHT. To exit, press the Jog Dial button. The input signal range is  $-/+8V$ .

### Setting menu

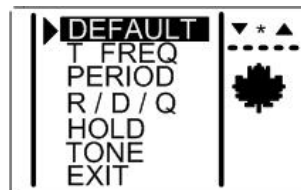

### DEFAULT

The default setting is optimal to perform fully automatic measurements for a resistance, inductance or capacitance.

### Test FREQUENCY

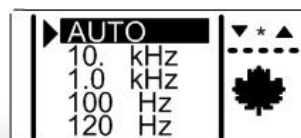

For automatic frequency setting select AUTO (default). Select fixed test frequency for specific measurements, such as a very small or a very large capacitance (less than 50pF or more than 100µF) or inductance.

#### PERIOD

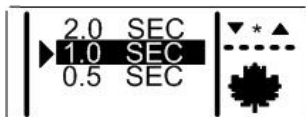

Period menu is used to set the period between measurements.

**Note:** Short period may reduce the battery life.

#### R/D/Q

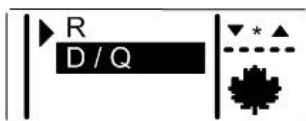

Use this menu to set secondary display parameter.

The following combinations are allowed:

C+R capacitance + resistance

C+D capacitance + dissipation factor

L+R inductance + resistances

L+Q inductance + quality factor

#### HOLD readings



Allows to hold last reading on display.

#### TONE



Enable or disable TONE mode for low resistance measurements. See section MEASUREMENT FEATURES for more information.

### MEASUREMENT FEATURES

This section describes specific ST functions and settings.

- Measuring resistance – Covers resistance measurements.
- Measuring capacitance – Covers capacitance measurements.

- Measuring inductance – Covers inductance measurements.
- Testing diodes – Describes testing general-purpose diodes.
- Measuring voltage – Covers DC voltage measurements and TRACE mode for dynamic signals.

#### ■ Measuring Resistance

Test frequency	1 kHz
Test signal amplitude	940 +/- 5% mVp-p (typical) Sine wave
Source impedance	620 ohm
Test period	1 Sec (default)

#### Measuring small resistance

There is some small resistance offset which reflects resistance of the tips, and resistance of the contacts between the tips and DUT. Typical offset value is less than 25 mΩ. The offset value should be used in calculation of the actual resistance.

#### Measurement Options:

There is an additional sound TONE mode controlled by the **TONE** setting:

If the measured resistance is less than 1 Ohm, sound signal changes the tone according to the measured resistance. The lower tone represents lower resistance. If the measured resistance is higher than 1 Ohm – the numbers of beeps represents the measured resistance.

Range	Number of BEEPS
1 Ω – 10 Ω	1
10 Ω – 20 Ω	2
20 Ω – 30 Ω	3
30 Ω – 40 Ω	4

**TONE** option is disabled by default.

#### ■ Measuring Capacitance

Test frequency	0.1 kHz, 1 kHz, 10 kHz
Test signal amplitude	940 mVp-p (typical) Sine wave
Source impedance	400 ohm
Test period	1 Sec (default)

In AUTO mode Smart Tweezers automatically select the best test frequency and capable of measuring capacitance from 4 pF to 4999 Ω F. If you need to measure capacitance lower than 4 pF select test frequency manually.

Range	Optimal test frequency
<10000pF	10 kHz
10001pF – 1 Ω F	1 kHz
> 1 Ω F	100 Hz



**Note:** Due to a low test signal level ST can show lower capacitance readings (about 60% of actual value) for some types of ceramic capacitor (e.g.X5R type).

There is some small capacitance offset that reflects capacitance of the tips and depends on the distance between the tips (i.e. measured component size). The offset value should be used in calculation of the actual capacitance.

Table below shows typical offset values for different component sizes:

Component size	Offset, pF
1206	1.58
0805	1.60
0603	1.65
0402	1.70

### ■ Measuring Inductance

Test frequency	0.1kHz, 1 kHz, 10kHz
Test signal amplitude	940 mVp-p (typical) Sine wave
Source impedance	400 ohm
Test period	1 Sec (default)

In AUTO mode ST automatically selects the best test frequency and is capable of measuring inductance from 1  $\Omega$  H to 1kH. If you need to measure inductance lower than 5 $\Omega$  H or more than 1 mH select test frequency manually:

Range	Optimal test frequency
<1 mH	10 kHz
100 $\Omega$ H – 100 mH	1 kHz
> 100 mH	100 Hz

### ■ Measuring Voltage

DC voltage measurements

Input resistance	1 M $\Omega$ +/- 1%
Measured range	-8V to +8V DC

Before making measurements, please perform offset calibration and change the slide switch position.

Offset calibration procedure:

1. Select CALIBRATION function in the VOLTAGE menu
2. Shorten the tips and wait until message DONE appears on the display
3. Release the tips. The device is ready to perform DC Voltage measurements.

Dynamic signals real time indication

Input voltage range	-8V to +8V AC
Input resistance	1 M $\Omega$

The refresh rate is limited by the LCD performance. User-defined refresh rate allows seeing either relatively fast or slow events. Before making measurements please change the slide switch position.

## MAINTENANCE

### General Maintenance

Dirt or moisture on the tips may affect measurement accuracy. Clean the tips regularly. Do not use abrasives or solvents.

To clean the tips:

1. Shake out any dirt that may be on the tips.
2. Soak a swab with alcohol. Work the swab around each tip.

### Batteries

ST uses three 1.4V–1.5V button type batteries, size 11.2x5.6 mm.

Alkaline type batteries: LR44, 357A, SG13, A76, AG13, L1154 etc.

Air Zinc type batteries: ZA675, VT675, XL675, 675A, etc.

### Low Battery Indication

The Low Battery message and battery icon on the display is an indication that the batteries are low and should be replaced. The warning appears when the battery voltage drops below 3.45V, i.e. the batteries are about 90% depleted. The unit is still operational for a short time; however the batteries should be replaced as soon as possible

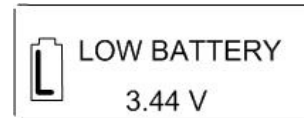

### To replace the batteries:

1. Remove three screws and lift the cover.
2. Replace the batteries following the “+” and “-” sign.
3. Secure the cover.

### Troubleshooting

If there appears to be a malfunction during an operation of the device, the following steps should be performed in order to isolate the cause of the problem:

1. Reset device by replacing batteries.
2. Check slide switch position. If necessary, change slide switch position and then reset the device again.
3. Check the batteries. If necessary, change them.
4. Review the operating instructions for possible mistakes in the operating procedure.

**CAUTION:** Except for replacing the battery, a repair of the device should only be performed by an Authorized Service Center or by qualified service personnel.

## LABELLING & VERIFICATION REQUIREMENTS

This device complies with Part 15 of the FCC Rules.

Operation is subject to the following two conditions:

1. This device may not cause harmful interference; and,
2. This device must accept any interference received, including interference that may cause undesired operation.

## APPENDIX A. SPECIFICATIONS

### Technical Specifications

AC test mode Test frequency:	1 kHz, 10 kHz, 120Hz, 100 Hz
Test frequency accuracy:	0.25%
Test signal level:	940 mVp-p +/- 20 mV Sine wave
Source impedance:	400Ω +/- 5%

Parameter	Measurement Range	Basic Measurement Accuracy*
Resistance	5 Ω to 999 kΩ	< 1.0%
	0.1 to 9.9 MΩ	< 5.0%
Capacitance	10 pF to 100 uF	< 3.0%
	0.5 pF to 4999 uF	< 5.0%
Q	0.1 to 100	
Inductance	10 uH to 99 mH	< 3.0%
	0.5 uH to 999 mH	< 5.0%
D	0.01 to 10	
DC voltage**	0V to 8V	< 1.0%

\* at optimum test frequencies, ranges, without calibration offset.

\*\* required DC voltage offset calibration

Auto mode Read-out:	Dominant parameter
Equivalent circuit diagram:	Parallel for C/R Serial for L/R
Manual Mode Read-out:	Dominant or secondary parameter
Equivalent circuit diagram:	Parallel or serial
Measurement update rate:	up to 4 measurements per second
Battery Type:	1.5V LR44 (357A) Alkaline or Air zinc
Battery Life:	70 Hours typical with alkaline, 200 hours with air zinc batteries
Calibration:	Recommended interval 1 year NIST traceable calibration

### Physical Specifications

Size:	14.0 x 2.5 x 3.0 cm (3.94 x 0.9 x 1.5 in)
Weight:	53 grams (0.11 lb)

### Environmental Conditions

Operating temperature:	0°C to 50°C
Storage temperature:	-40°C to 70°C

Relative Humidity:	0% to 90% (0°C to 35°C)
Altitude Operating:	0 – 2000 meters
EMC:	According to CE regulation 89/336, Emission according FCC15 Class B.

## APPENDIX B. DEFAULT SETTINGS

### Default settings after RESET

SOUND mode:	OFF
DISPAY mode:	Right
Contrast:	FACTORY settings
Readings PERIOD:	1 sec
Measurement mode:	AUTO
Test frequency mode:	AUTO
Offset CALIBRATION:	FACTORY settings

### Default settings after AUTOSET command

SOUND mode:	OFF
DISPAY mode:	No change
Contrast:	No change
Readings PERIOD:	1 sec
Measurement mode:	AUTO
Test frequency mode:	AUTO
Offset CALIBRATION:	No change

## APPENDIX C. SERVICE REQUEST FORM

Model No. \_\_\_\_\_ Serial No. \_\_\_\_\_

Date \_\_\_\_\_

Name \_\_\_\_\_

Company \_\_\_\_\_

Address \_\_\_\_\_  
\_\_\_\_\_

E-mail \_\_\_\_\_ Telephone No \_\_\_\_\_

List all settings, describe problem and check boxes that apply.

\_\_\_\_\_

\_\_\_\_\_

### Power

Problem on power-up

Device does not turn-off

Other \_\_\_\_\_

### LCD

No image on LCD

Missing vertical or horizontal lines

Bad contrast

Other \_\_\_\_\_

### Mechanical

Jog Dial

Slide Switch

Tips

Other \_\_\_\_\_

### Measurements

SMT component

non-SMT component

Is it an in-circuit measurement?

\_\_\_\_\_

**Capacitor**

**Inductor**

**Resistor**

Type (ceramic, tantalum, etc) \_\_\_\_\_

Value ( $\mu\text{F}$ ,  $\text{pF}$ ,  $\mu\text{H}$ ,  $\Omega$ , etc.) \_\_\_\_\_

Test Frequency? \_\_\_\_\_ Ambient temperature? \_\_\_\_\_

Humidity? \_\_\_\_\_

Other \_\_\_\_\_

Additional information (attach any additional sheets as necessary)

Show a block diagram of your measurement including all devices connected (whether power is turned on or not). If applicable, describe signal source.

\_\_\_\_\_

\_\_\_\_\_

\_\_\_\_\_

Calibration only (Certificate of calibration required)

Be sure to include your name and phone number or e-mail on this service form.

## APPENDIX D. ACCURACY SPECIFICATION

Parameter	Measurement Range	Basic Measurement Accuracy*
Resistance	1Ω to 999 kΩ	< 1.0%
	0.1 to 9.9 MΩ	< 5.0%
Capacitance	10 pF to 100 uF	< 3.0%
	0.5 pF to 4999 uF	< 5.0%
Inductance	10 uH to 99 mH	< 3.0%
	0.5 uH to 999 mH	< 5.0%
DC voltage**	0V to +/-8V	< 1.0%

\* at optimum test frequency, ranges, without calibration offset

\*\* required DC voltage offset calibration

### Typical offset:

Resistance  $\leq 25 \text{ m}\Omega$

Capacitance 1.65 pF

Inductance 0.15 uH

Offset value should be subtracted from measurement result for small value components ( $R < 10\Omega$ ,  $C < 100 \text{ pF}$ ,  $L < 10 \text{ uH}$ ).

Parameter	Measurement Range	Test frequency
Resistance	< 9.9 MΩ	1 kHz
Capacitance	< 9999 pF	10 kHz
	10000 pF to 1 uF	1 kHz
	> 1 uF	100 Hz
Inductance	0.5 uH to 99 uH	10 kHz
	100 uH 99 mH	1 kHz
	> 100 mH	0.1 kHz

### Maximum measurement ranges

Resistance R: 0.05Ω to 9.9 MΩ

Capacitance C: 0.5 pF to 4999 uF

Inductance L: 0.5 uH to 999 mH

Quality factor Q: 0.002 to 500 \*

Dissipation factor D: 0.002 to 500 \*

DC Voltage V: 0 to +/- 8V

### Maximum resolution

Impedance/Resistance Z or RAC: 10 mΩ

Capacitance C: 0.1 pF

Inductance L: 0.1 uH

Quality factor Q: 0.001

Dissipation factor D: 0.001

Phase angle F: 0.1 deg

DC voltage V: 0.8 mV

\* indication of the parameter not implemented in some versions